

# MRO Kits

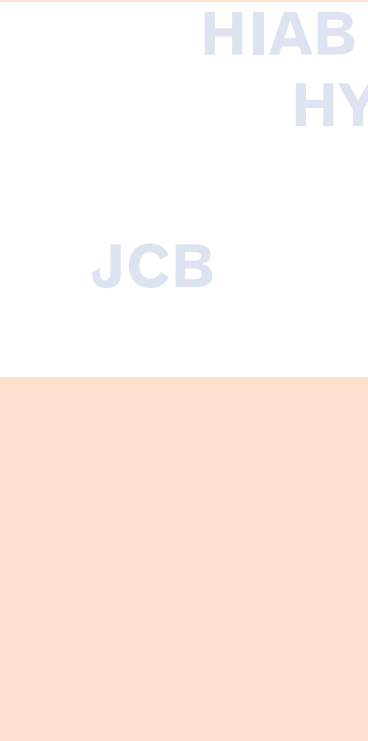

We at Barnwell recognize the trend towards the supply of quality sealing kits, tailored to suit the specific requirements of maintenance, repair and overhaul (MRO). We supply after market replacement kits for the major makes of machinery and vehicles for construction, materials handling, agriculture and off road applications. The fact that we carry one of the largest stocks of sealing products in the UK under one roof means that we are able to respond to customer requirements quickly and efficiently.

**Contact Barnwell  
– the Kits Specialists!**

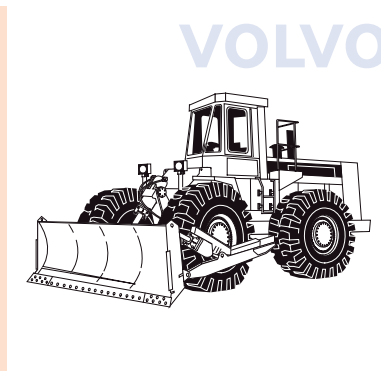
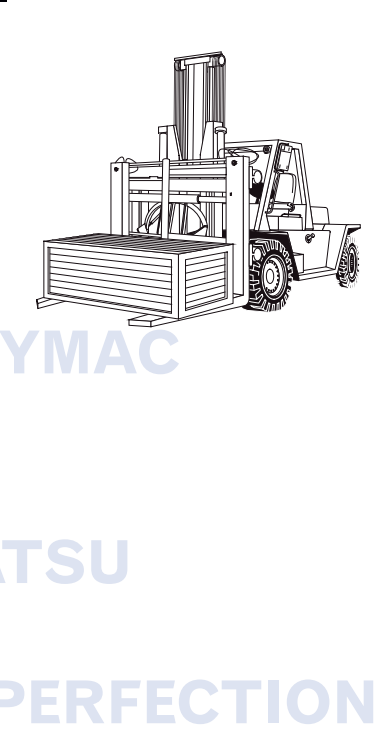
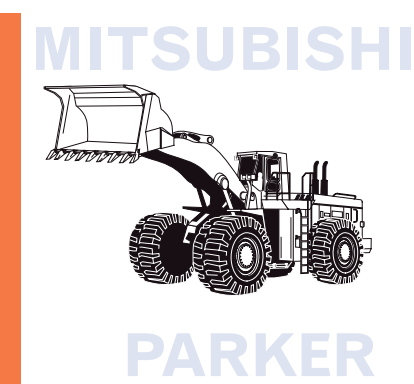
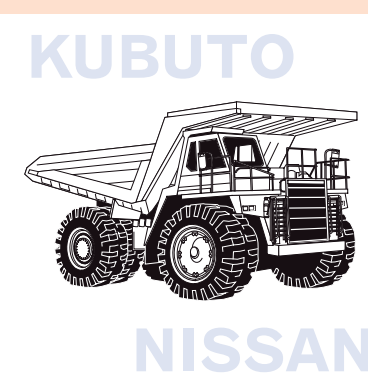

## The Barnwell Portfolio

An extensive range of quality sealing products and services are available, including:

- Rotary Shaft Seals
- 'O' Rings
- Hydraulic & Pneumatic Seals
- Gaskets & Packings
- Sealing Washers
- Rubber Mouldings & Extrusions
- Circlips
- Adhesives & Sealants
- Springs & Fasteners
- Workshop Consumables
- Image Branding Service
- Bespoke Kits

Contact your local Barnwell Service Centre...  
...or phone our special Sales Hotline:

**0121 420 0770**

**Headquarters and Central Warehouse**  
M Barnwell Services Ltd,  
Reginald Road, Smethwick  
West Midlands B67 5AS  
Tel 0121 429 8011  
Fax 0121 434 3016  
e-mail sales@barnwell.co.uk

**Dartford**  
Unit 7 Schooner Park,  
Crossways Business Park,  
Dartford, Kent DA2 6QG  
Tel 01322 293024  
Fax 01322 272099  
e-mail dartford@barnwell.co.uk

**Bellshill**  
Unit 14 & 16, Murray Place,  
Righead Industrial Estate,  
Bellshill, Lanarkshire ML4 3LJ  
Tel 01698 749666  
Fax 01698 749888  
e-mail scotland@barnwell.co.uk

**Manchester**  
Unit 36/37, Westbrook Trading Estate,  
Westbrook Road, Trafford Park,  
Manchester M17 1AY  
Tel 0161 888 2330  
Fax 0161 888 2296  
e-mail manchester@barnwell.co.uk

**Bristol**  
Unit 13, Avonbank Industrial Centre,  
West Town Road, Avonmouth,  
Bristol BS11 9DE  
Tel 0117 982 5245  
Fax 0117 923 5623  
e-mail bristol@barnwell.co.uk

**Export**  
Tel 0121 429 8011  
Fax 0121 420 3080  
e-mail export@barnwell.co.uk



BS EN ISO 9001:2000 (STOCKIST)  
CERTIFICATE NUMBER RS 00530

MBSL25/08/07

Visit us on the web at  
[www.barnwell.co.uk](http://www.barnwell.co.uk)



**Stockholding and Supply.**  
Items in this brochure may not necessarily be manufactured under an ISO recognised management system. © All trademarks acknowledged.  
**M. Barnwell Services Ltd** endeavours to ensure that the information contained in this publication pertaining to products and services is correct and fairly stated. However, we do not accept any liability for any errors or omissions therein. Reproduction in whole or in part of this publication without our written authorisation is prohibited.

# Hydraulic and Pneumatic Seals



**Quality  
sealing  
solutions**



# Advanced Sealing Technology



Sealing materials have evolved significantly over the last fifty years. Improved quality, performance and seal designs have changed our conceptions of fluid sealing.

Barnwell is at the forefront of sealing technology, with over 30 years experience in providing industry with sealing solutions, backed up by guaranteed product quality and technical expertise.

We hold one of the largest stocks of Hydraulic and Pneumatic Seals in the UK, at our headquarters near Birmingham. They are available in a broad range of profiles and standard or special compounds, to suit a vast number of applications.

Each of our Customer Service Centres in Aylesbury, Bellshill, Bristol, Manchester and Smethwick are staffed by experienced, professional people, on hand to provide solutions for all your sealing problems.

So contact them now for more information, or use our special Sales Hotline:

**0121 420 0770**





**DESIGN**

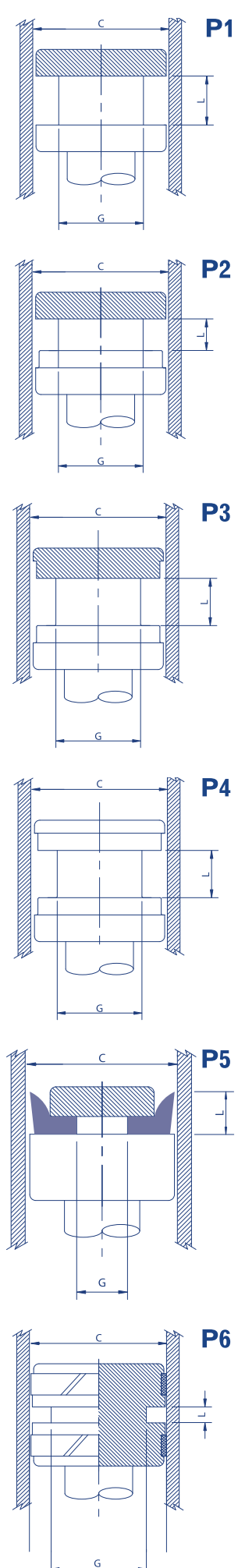

**PISTON SEALS**

PROFILE	DESIGN	REFERENCE	P.S.I./BAR	MATERIAL	CYLINDER DIA.	SIZE LISTING
	P1	FS (imperial)	PSI 3000	NBR + FABRIC	1/2 - 20	FS (CxGxL)
		FSM (metric)	BAR 200		13 - 490	FSM (GxCxL)
	P1	FSO	PSI 6000	NBR + FABRIC +ACETAL	1 - 8 1/2	FSO (CxGxL)
		FSOM	BAR 400		25 - 360	FSOM (GxCxL)
	P1	FGS	PSI 3000	NBR + FABRIC	1 - 7	FGS (CxGxL)
		FGSM	BAR 200		40 - 110	FGSM (GxCxL)
	P1	FGSO	PSI 6000	NBR + FABRIC +ACETAL	1 1/8 - 7	FGSO (CxGxL)
		FGSOM	BAR 400		32 - 200	FGSOM (GxCxL)
	P2	FS-W	PSI 6000	NBR + FABRIC +ACETAL	1 - 7 1/4	FS (CxGxL)W
		FSM-W	BAR 400		25 - 140	FSM (GxCxL)W
	P2	FGS	PSI 6000	NBR + FABRIC +ACETAL	1 1/8 - 7	FGS (CxGxL)W
		FGSM-W	BAR 400		50 - 142	FGSM (GxCxL)W
	P2	FS-L	PSI 6000	NBR + FABRIC +ACETAL	1 - 7	FS (CxGxL)L
		FSM-L	BAR 400		25 - 280	FSM (GxCxL)L
	P1	PU	PSI 6000	POLYURETHANE	9/16 - 14	PU (CxGxL)
		PUM	BAR 400		10 - 360	PUM (GxCxL)
	P1	BVP	PSI 10000	NBR + FABRIC OR ACETAL	15/16 - 26	BVP (CxGxL)
		MBVP	BAR 700		22 - 600	MBVP (GxCxL)
	P1	U	PSI 2000	NBR	5/16 - 20	U (CxGxL)
		UM	BAR 150		10 - 500	UM (GxCxL)
	P1	FU	PSI 2600	NBR + FABRIC	5/8 - 10 1/2	FU (CxGxL)
		BAR 180				
	P1	DE	PSI 1500	NBR	3/8 - 14	DE (CxGxL)
		DEM	BAR 100		12 - 250	DEM (GxCxL)
	P1	FD	PSI 3000	NBR + FABRIC	3/4 - 16	FD (CxGxL)
		FDM	BAR 200		25 - 580	FDM (GxCxL)
	P3	FD-W	PSI 6000	NBR + FABRIC +ACETAL	1 - 9 1/2	FD (CxGxL)W
		FDM-W	BAR 400		25 - 250	FDM (GxCxL)W
	P3	FD-L	PSI 6000	NBR + FABRIC +ACETAL	3/4 - 10	FD (CxGxL)L
		FDM-L	BAR 400		25 - 280	FDM (GxCxL)L
	P4	OPI	PSI 6000	NBR + POLYESTER +ACETAL	1 - 8	OPI (CxGxL)W
		OPM	BAR 400		25 - 320	OPM (GxCxL)W
	P4	OPI	PSI 3000	NBR + POLYESTER +ACETAL	1 - 4	OPI (CxGxL)L
		OPM	BAR 200		25 - 125	OPM (GxCxL)L
	P4	SDM	PSI 6000	NBR + FABRIC +ACETAL	25 - 250	SDM (GxCxL)L
		BAR 400				
	P5	MBFC	PSI 2500	NBR + FABRIC	5/8 - 8 1/4	MBFC (CxGxL)
		BAR 170			40 - 95	MBFC (GxCxL)
	P5	MBRC	PSI 500	NBR	1/4 - 16	MBRC (CxGxL)
		BAR 35			8 - 550	MBRC (GxCxL)

In addition to the standard seal profiles shown here, Barnwell stocks a substantial range of other sealing products, including Wear Rings in various materials - Far Eastern and American product ranges, plus non standard designs. This allows Barnwell to offer the complete solution for hydraulic and pneumatic seal requirements.

**DESIGN**

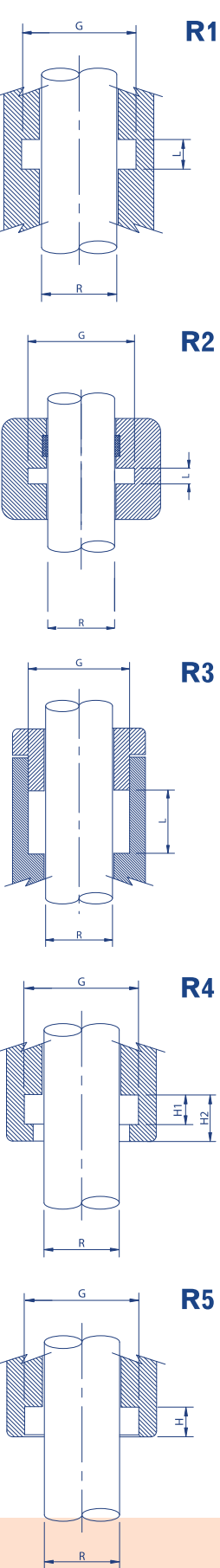

**ROD SEALS**

PROFILE	DESIGN	REFERENCE	P.S.I./BAR	MATERIAL	ROD DIA.	SIZE LISTING
	R1	FS (imperial)	PSI 3000	NBR + FABRIC	3/16 - 18	FS (GxRxL)
		FSM (metric)	BAR 200		6 - 450	FSM (RxGxL)
	R1	FSI	PSI 6000	NBR + FABRIC +ACETAL	5/16 - 6 1/2	FSI (GxRxL)
		FSIM	BAR 400		12 - 340	FSIM (RxGxL)
	R1	FGS	PSI 3000	NBR + FABRIC	5/8 - 6	FGS (GxRxL)
		FGSM	BAR 200		30 - 90	FGSM (RxGxL)
	R1	PU	PSI 6000	POLYURETHANE	1/4 - 12	PU (GxRxL)
		PUM	BAR 400		5 - 400	PUM (RxGxL)
	R1	PDI	PSI 6000	POLYURETHANE	3/8 - 10	PDI (GxRxL)
		PDIM	BAR 400		4 - 360	PDIM (RxGxL)
	R1	U	PSI 2000	NBR	1/8 - 18 1/2	U (GxRxL)
		UM	BAR 150		2 - 450	UM (RxGxL)
	R1	FU	PSI 2600	NBR + FABRIC	1/4 - 9 1/4	FU (GxRxL)
		BAR 180				
	R1	DI	PSI 2000	NBR	1/8 - 9	DI (GxRxL)
		DIM	BAR 150		3 - 180	DIM (RxGxL)
	R3	BVP	PSI 10000	NBR + FABRIC OR ACETAL	1/2 - 24	BVP (GxRxL)
		MBVP	BAR 700		12 - 600	MBVP (RxGxL)
	P6	CPS	PSI 6000	FILLED PTFE + ENERGISER	1/4 - 20	CPS (CxGxL)
		CRS	BAR 400		3 - 500	CRS (RxGxL)
	P6	CPS	PSI 6000	FILLED PTFE + ENERGISER	3/8 - 20	CPS (CxGxL)
		CRS	BAR 400		8 - 500	CRS (RxGxL)
	P6	CPS	PSI 6000	POLYURETHANE + ENERGISER	2 - 5	CPS (CxGxL)
		BAR 400			20 - 200	
	R4	MBW		NBR	3/8 - 8	MBW (RxGxH)
	R4	MBWO		NBR	1/2 - 8	MBWO (RxGxH)
	R4	MBWM		NBR OR POLYURETHANE	3/4 - 5	MBWM (RxGxH1xH2)
					12 - 200	MBWM (RxGxH1xH2)
	R4	MBWS		NBR	5/8 - 6	MBWS (RxGxH1xH2)
					16 - 150	MBWS (RxGxH1xH2)
	R4	MBY		POLYACETAL	3/8 - 18	MBY (RxGxH1xH2)
		MBYM			12 - 450	MBYM (RxGxH1xH2)
	R4	MBA1		NBR	4 - 500	MBA1 (RxGxH1xH2)
	R5	AS		NBR OR POLYURETHANE + STEEL	1/2 - 4	AS (RxGxH)
					6 - 400	
	R5	RS		NBR OR POLYURETHANE + STEEL	3/4 - 4	RS (RxGxH)
					6 - 220	

**COMPOSITE SEALS**

**WIPER SEALS**

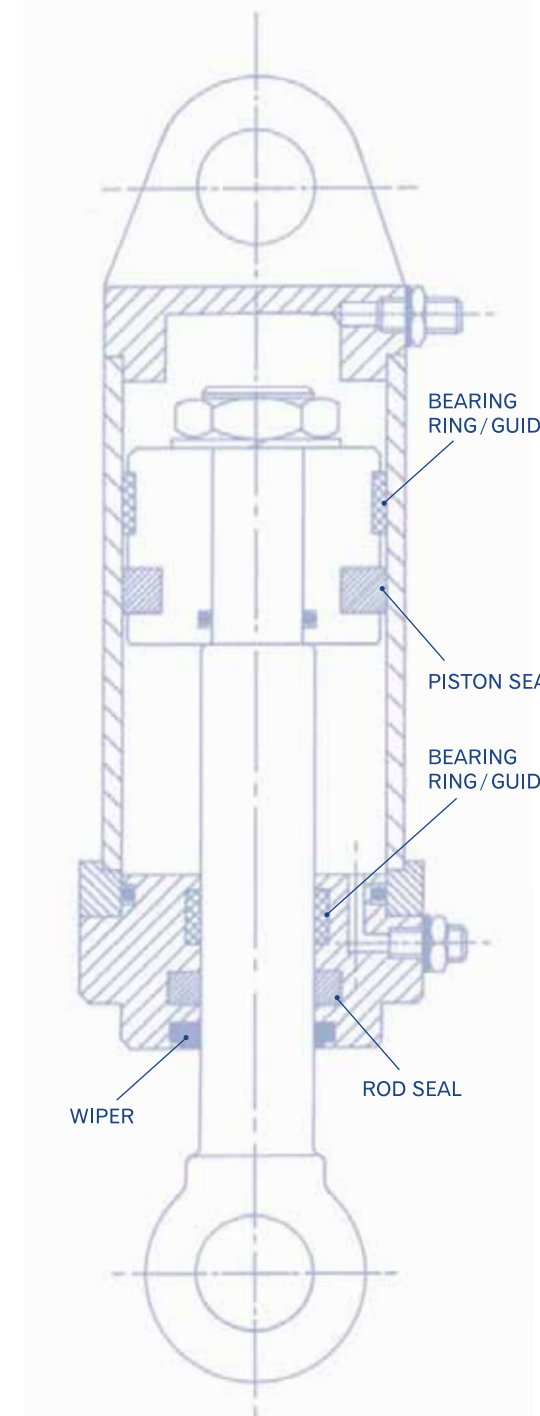

Technical advice, product samples and site visits from our team of experienced Sales Engineers are always available.

For special designs/profiles, ask for information on our Seal Maker Service.

Working limits may vary, dependant on working conditions/metalwork dimensions.

